



# CIRCLE LED BASE



## Extend the day with sustainable lighting solutions

The evolution of new technologies has more than ever raised the need to reconsider how we preserve our legacy. At Schröder, we understand the importance of upholding heritage while embracing innovation. That's why circular economy is at the heart of our product design. Our commitment to sustainability starts from the concept phase, where we carefully consider the production method and environmental impact. Our luminaires are designed to be used for an extended lifespan without being limited by technological obsolescence.

In this vein, we have developed CIRCLE LED BASE, a LED lighting retrofit solution that allows you to update your existing light sources while extending the lifetime of the luminaire. With CIRCLE LED BASE, you can seamlessly integrate the latest lighting innovations into your heritage luminaires, avoiding the need for costly replacements and unnecessary waste. Discover our sustainable lighting solutions and join us on the journey towards a brighter and greener future.

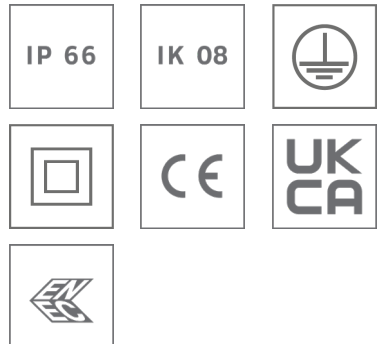

## Concept

CIRCLE LED BASE is part of the Schröder Circle Light Ecosystem that enables needless waste to be avoided while complying with lighting pollution regulations, minimising maintenance operations and saving energy.

The CIRCLE LED BASE retrofit solutions have been designed to integrate perfectly with existing Schröder luminaires while delivering the same level of excellence as brand new ones.

CIRCLE LED BASE is available in two sizes, with a wide range of optics, LED colours and light distributions, allowing any type of lighting installation to be upgraded. No matter what environmental, local regulation or project requirements there are, CIRCLE LED BASE delivers. With light colours from 1800K ambered to 5700K white, this retrofit lighting solution complies with all local standards while preserving flora and fauna at night.

As part of our sustainability commitment, CIRCLE LED BASE uses recyclable materials in a robust design offering high mechanical and tightness levels. Its IP66 cover makes it fully watertight, enabling the retrofitting of old lanterns that would not offer the tightness protection of the latest LED technology.

CIRCLE LED BASE does not require any new wiring or any lighting infrastructure modifications either. Quick and easy integration is ensured using quick connectors or cable glands.

This retrofit kit solution is available with intelligent drivers, allowing compatibility with the Schröder Circle Light App for easy onsite driver programming and remote luminaire asset management of your upgraded light installation.



CIRCLE LED BASE is a sustainable retrofit solution that extends the lifespan of your existing luminaires while preserving their integrity.



CIRCLE LED BASE can be delivered with an adaptation plate for perfect integration into the intended luminaire.

## TYPES OF APPLICATION

- URBAN & RESIDENTIAL STREETS
- BRIDGES
- BIKE & PEDESTRIAN PATHS
- RAILWAY STATIONS & METROS
- CAR PARKS
- SQUARES & PEDESTRIAN AREAS
- ROADS & MOTORWAYS

## KEY ADVANTAGES

- Maximised savings in energy and maintenance costs
- Easy installation
- Durable and recyclable materials
- Sustainable lighting solution that extends the lifespan of luminaires.
- Reduces environmental impact and the carbon footprint.
- Facilitates component removal, increases the standardisation of parts and materials separability.



Its wide range of LED colours, distributions and optics enables any luminaire in any kind of environment to be retrofitted.

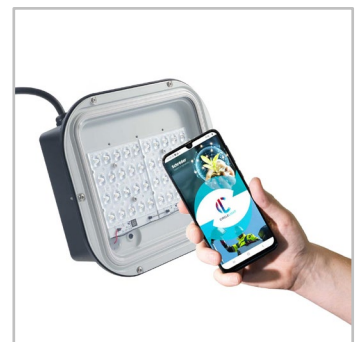

The Schröder Circle Light App allows on-site programming and one-to-one replacement of drivers while retaining the same programming, further extending the life of the retrofit kit.

CIRCLE LED BASE | ONYX 2 retrofitted with CLB 1



CIRCLE LED BASE | ONYX 2 retrofitted with CLB 2



CIRCLE LED BASE | CMS Mini (HID) retrofitted with CLB 1



CIRCLE LED BASE | CMS Mini (HID) retrofitted with CLB 2



CIRCLE LED BASE | HESTIA (HID) retrofitted with CLB 1



CIRCLE LED BASE | HESTIA (HID) retrofitted with CLB 2



CIRCLE LED BASE | VALENTINO (HID) retrofitted with CLB 1



CIRCLE LED BASE | VALENTINO (HID) retrofitted with CLB 2





LensoFlex<sup>®</sup>4

LensoFlex<sup>®</sup>4 maximises the heritage of the LensoFlex<sup>®</sup> concept with a very compact yet powerful photometric engine based upon the addition principle of photometric distribution. The number of LEDs in combination with the driving current determines the intensity level of the light distribution. With optimised light distributions and very high efficiency, this fourth generation enables the products to be downsized to meet application requirements with an optimised solution in terms of investment.

LensoFlex<sup>®</sup>4 optics can feature backlight control to prevent intrusive lighting, or a glare limiter for high visual comfort.

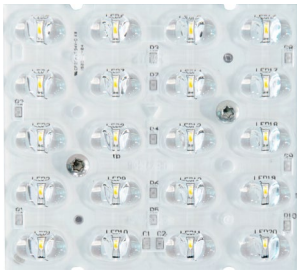

HiFlex<sup>™</sup>

The HiFlex platform is expertly designed to optimise energy efficiency. Its photometric engines feature high-power LEDs that deliver exceptional performance while consuming minimal energy, resulting in unmatched efficacy (lm/W).

Ideal for projects that require a streamlined approach to maximising lighting efficacy and achieving swift ROI, HiFlex is available in two versions: HiFlex 1, boasting 24 LEDs and HiFlex 2, equipped with 36 LEDs. Both variants are designed with the priorities of compactness, cost-effectiveness and high performance in mind.



## Custom dimming profile

Intelligent luminaire drivers can be programmed with complex dimming profiles. Up to five combinations of time intervals and light levels are possible. This feature does not require any extra wiring.

The period between switching on and switching off is used to activate the preset dimming profile. The customised dimming system generates maximum energy savings while respecting the required lighting levels and uniformity throughout the night.

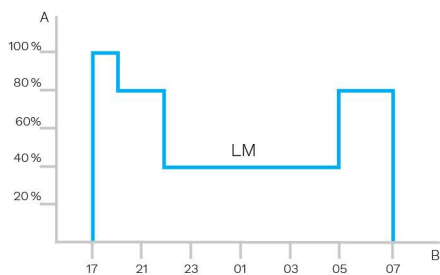

A. Dimming level | B. Time

With the PureNight concept, Schröder offers the ultimate solution for restoring the night sky without switching off cities, while maintaining safety and well-being for people and preserving wildlife. The PureNight concept guarantees that your Schröder lighting solution satisfies environmental laws and requirements. Well-designed LED lighting has the potential to improve the environment in all respects.

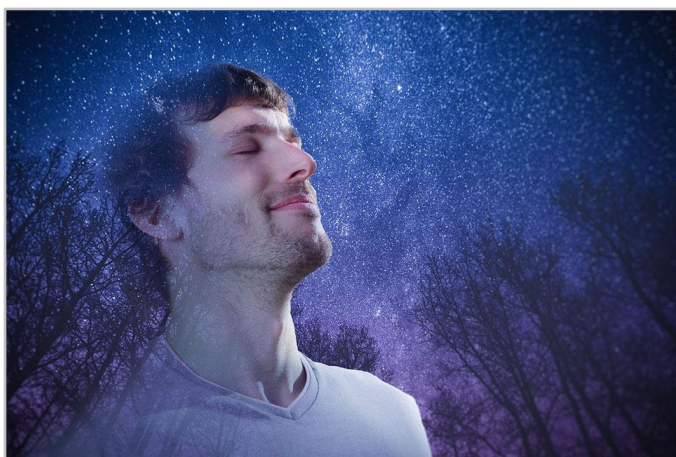

## Protect wildlife

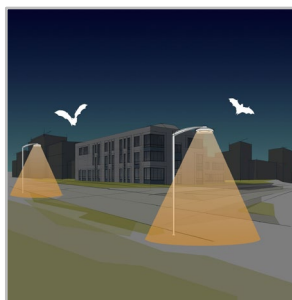

If not well designed, artificial lighting can badly affect wildlife. Blue light and excessive intensity can have a damaging effect on all types of life. Blue light radiation has the ability to suppress the production of melatonin, the hormone that contributes to the regulation of the circadian rhythm. It can also alter the behavioural patterns of animals including bats and moths, as it can change their movements towards or away from light sources. Schröder favours warm white LEDs with minimal blue light, combined with advanced control systems including sensors. This enables permanent adaptation of the lighting to the real needs of the moment, minimising disturbance to the fauna and flora.

## Get the starry sky back



The Upward Light Ratio (ULR) and Upward Light Output Ratio (ULOR), the latter taking the flux from the luminaire into account, provide information on the percentage of light emitted towards the sky. This Schröder range of luminaires minimises or eliminates (depending on the options) upward-directed light flux. It complies with strict international and local requirements.

## Direct the light only where it is wanted and needed

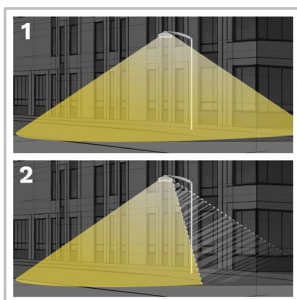

Schröder is renowned for its expertise in photometry. Our optics direct light only where it is wanted and needed. However, light trespass behind the luminaire might be a key concern when it comes to protecting a sensitive wildlife habitat or avoiding intrusive lighting towards buildings. Our fully integrated backlight solutions easily address this potential risk.

1. Without backlight
2. With backlight

## Offer maximum visual comfort to people



Because of the lower installation height compared to road lighting, visual comfort is an essential aspect of urban lighting. Schröder designs lenses and accessories to minimise any type of glare (distracting, discomforting, disabling glare and blinding glare). Our design offices harness a range of possibilities to find the best solutions for each project and ensure that we provide a gentle light that delivers the best night-time experience.

## GENERAL INFORMATION

Recommended installation height	4m to 15m   13' to 49'
FutureProof	Easy replacement of the photometric engine and electronic assembly
Circle Light label	Score $\geq 90$ - The product fully meets circular economy requirements
Driver included	Yes
CE mark	Yes
ENEC certified	Yes
UKCA marking	Yes

## HOUSING AND FINISH

Housing	Aluminium Polypropylene
Optic	PMMA
Protector	Tempered glass Frosted glass Polycarbonate
Housing finish	Polyester powder coating
Standard colour(s)	RAL 9003 signal white RAL 7040 window grey AKZO grey 900 sanded
Tightness level	IP 66
Impact resistance	IK 08

## OPERATING CONDITIONS

Operating temperature range (Ta)	-30°C up to +50°C / -22°F up to 122°F with wind effect
----------------------------------	--

· Depending on the luminaire configuration. For more details, please contact us.

## ELECTRICAL INFORMATION

Electrical class	Class I EU, Class II EU
Nominal voltage	120-277V – 50-60Hz 220-240V – 50-60Hz
Surge protection options (kV)	10
Electromagnetic compatibility (EMC)	EN 55015 / EN 61000-3-2 / EN 61000-3-3 / EN 61547
Control protocol(s)	1-10V, DALI
Control options	AmpDim, Custom dimming profile

## OPTICAL INFORMATION

LED colour temperature	2200K (Warm White WW 722)
	2700K (Warm White WW 727)
	3000K (Warm White WW 730)
	3000K (Warm White WW 830)
	4000K (Neutral White NW 740)
	5700K (Cool White CW 757)
Colour rendering index (CRI)	>70 (Warm White WW 722)
	>70 (Warm White WW 727)
	>70 (Warm White WW 730)
	>80 (Warm White WW 830)
	>70 (Neutral White NW 740)
	>70 (Cool White CW 757)
ULOR	0%
ULR	0%

· ULOR may be different according to the configuration. Please consult us.  
· ULR may be different according to the configuration. Please consult us.

## LIFETIME OF THE LEDS @ TQ 25°C

All configurations	100,000h - L92
--------------------	----------------

· Lifetime may be different according to the size/configurations. Please consult us.



## DIMENSIONS AND MOUNTING

AxBxC (mm | inch)

CIRCLE LED BASE 1 : 243x93x193 | 9.6x3.7x7.6

CIRCLE LED BASE 2 : 277x93x243 | 10.9x3.7x9.6

Weight (kg | lbs)

CIRCLE LED BASE 1 : 3.0-3.3 | 6.6-7.3

CIRCLE LED BASE 2 : 3.6-4.0 | 7.9-8.8

Mounting possibilities

Retrofit kit

· For more information about mounting possibilities, please consult the installation sheet.

· The dimensions and weights are given with the IP cover. For further information about product weights and dimensions, please consult us.

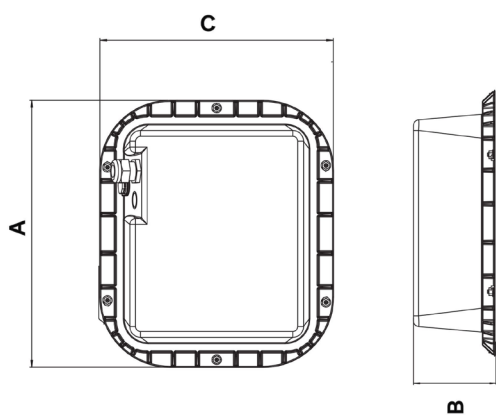

CIRCLE LED BASE | With cable gland

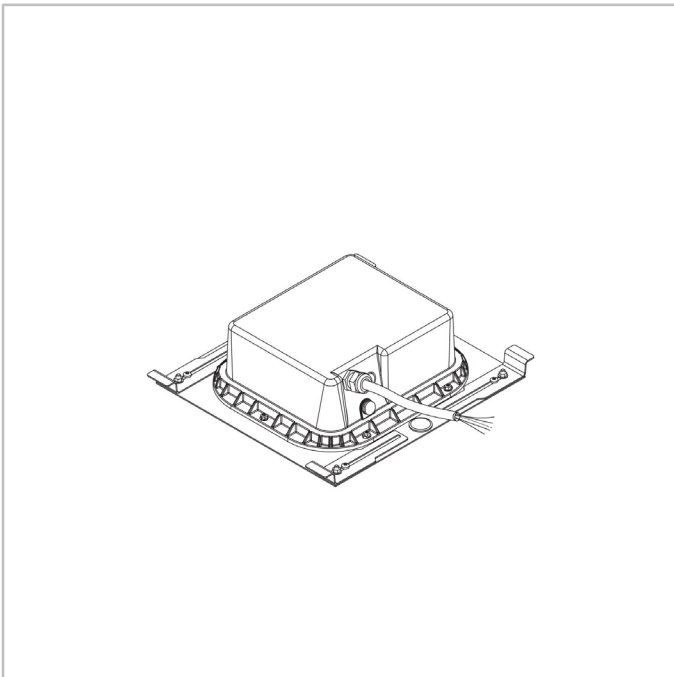

CIRCLE LED BASE | With QPD connector

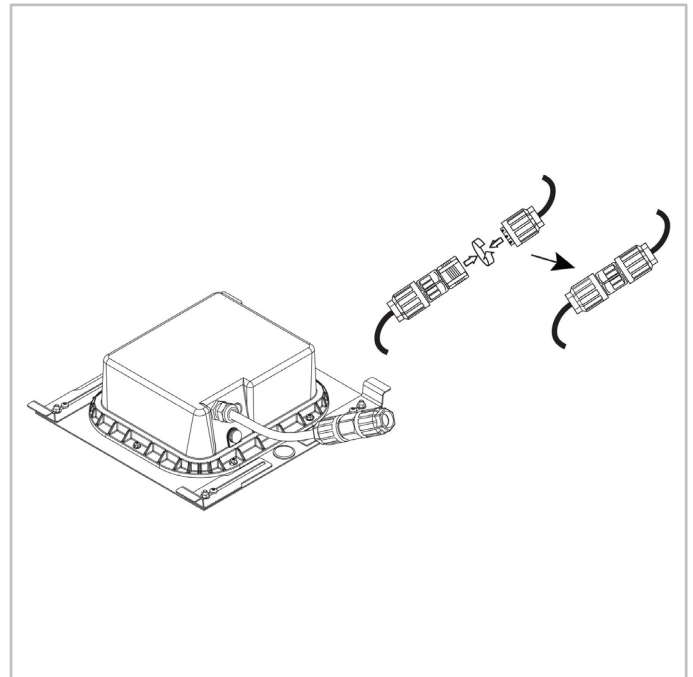

CIRCLE LED BASE | With quick-on connector

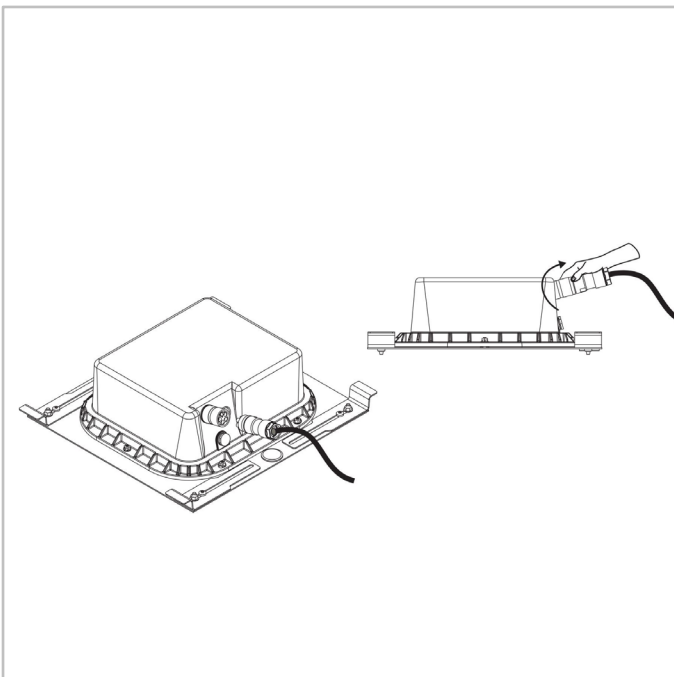



Number of LEDs	Luminaire output flux (lm)								Power consumption (W)		Luminaire efficacy (lm/W)
	Warm White WW 722		Warm White WW 727		Warm White WW 730		Neutral White NW 740				
	Min	Max	Min	Max	Min	Max	Min	Max	Min	Max	Up to
36	1700	8400	1900	9500	2000	9900	2200	10600	15	70	167

Tolerance on LED flux is ± 7% and on total luminaire power ± 5%



Number of LEDs	Luminaire output flux (lm)								Power consumption (W)		Luminaire efficacy (lm/W)
	Warm White WW 722		Warm White WW 727		Warm White WW 730		Neutral White NW 740				
	Min	Max	Min	Max	Min	Max	Min	Max	Min	Max	Up to
72	3600	12800	4100	14500	4200	15000	4600	16200	28	100	178

Tolerance on LED flux is ± 7% and on total luminaire power ± 5%



Number of LEDs	Luminaire output flux (lm)								Power consumption (W)		Luminaire efficacy (lm/W)
	Warm White WW 722		Warm White WW 727		Warm White WW 730		Neutral White NW 740				
	Min	Max	Min	Max	Min	Max	Min	Max	Min	Max	Up to
24	1000	6000	1100	6800	1200	7100	1300	7600	11	52	158

Tolerance on LED flux is ± 7% and on total luminaire power ± 5%



Number of LEDs	Luminaire output flux (lm)								Power consumption (W)		Luminaire efficacy (lm/W)
	Warm White WW 722		Warm White WW 727		Warm White WW 730		Neutral White NW 740		Min	Max	Up to
	Min	Max	Min	Max	Min	Max	Min	Max			
48	2100	11200	2300	12700	2400	13200	2600	14200	19	99	168

Tolerance on LED flux is ± 7% and on total luminaire power ± 5 %



Number of LEDs	Luminaire output flux (lm)												Power consumption (W)		Luminaire efficacy (lm/W)
	Warm White WW 722		Warm White WW 727		Warm White WW 730		Warm White WW 830		Neutral White NW 740		Cool White CW 757		Min	Max	Up to
	Min	Max	Min	Max	Min	Max	Min	Max	Min	Max	Min	Max			
20	1100	5500	1200	6300	1400	6900	1300	6500	1500	7300	1400	7100	13	58	160
25	1500	5800	1800	6700	1900	7400	1800	6900	2000	7800	2000	7600	16	60	161

Tolerance on LED flux is ± 7% and on total luminaire power ± 5 %



Number of LEDs	Luminaire output flux (lm)												Power consumption (W)		Luminaire efficacy (lm/W)
	Warm White WW 722		Warm White WW 727		Warm White WW 730		Warm White WW 830		Neutral White NW 740		Cool White CW 757		Min	Max	Up to
	Min	Max	Min	Max	Min	Max	Min	Max	Min	Max	Min	Max			
40	2400	10000	2600	10400	2800	11400	2600	10700	3000	12100	-	-	24	88	172
50	3100	10400	3600	10800	3900	11900	3700	11200	4100	12600	4000	12300	30	90	164

Tolerance on LED flux is ± 7% and on total luminaire power ± 5 %

